

Venture for  
Tomorrow

KOTEC: No. 20100105398  
Exposed method patent: 1 case  
Non-exposed method patent: 10 cases  
Root penetration resistance method patent  
Penetrant method patent: 1 case

kiat

Korea Institute  
for Advancement of Technology  
Korea Institute

For Advancement of Technology  
R&D dedicated department No.  
2011150049

Composite Waterproofing Construction System

# AHJIN LAYER

## Composite waterproofing method

**AHJINLAYER®**

[www.ahjinlayer.co.kr](http://www.ahjinlayer.co.kr)

The company specializing in eco-friendly waterproofing materials for people – Ahjin Layer

**Reduction of construction cost**

Strengthening the competitiveness

**Customer satisfaction**

Prevention of leaching after construction

**Eco-friendly**

Completing the development of eco-friendly products

**Essential condition of all waterproofing**  
**– Ahjin Layer’s waterproofing method**

Many products have been developed and commercialized with the Ahjin Layer's own technology. The test standards for the newly applied construction method are fulfilled, and the product development is carried out with our own technology.

- The **cold glue** coating agent with excellent behavior responsiveness
- The **glue sheet** material with excellent wet adhesion performance
- The **cold gel** coating agent with excellent elongation
- The **cold spi** coating agent with enhanced construction convenience
- The **aqueous urea** exposed waterproofing agent without VOCs emission
- The **butyl gum primer** with enhanced adhesion and others

Through the above method, about 35% in labor costs were able to be saved compared to our competitors, and about KRW 3,000,000 in defect repair costs (estimated per an apartment building unit) could also be saved with the no sagging or flowing down technology.

In addition, it has been demonstrated that the workability of the coating agent is excellent as its viscosity is similar throughout the four seasons and there is definitely no leaching after the construction with this method, therefore, we are absolutely trusted by our customers when it comes to the use of our product.

We will be reborn as a manufacturer that exerts their best efforts in the development of the method which can make the construction more easily in the future, that is, the method which can yield more profit without defects.

Representative Director **Kang Yong-seok**



AHJINLAYER®



# AHJINLAYER

Vertical waterproofing

AHJINLAYER® 3

# History

## 2022

- Hydrophilic hybrid primer development
- Geumwang Techno Valley Factory Construction
- KS certification (horizontal, vertical coating agent) in preparation
- Acquired venture business certification

## 2021

- Green technology certification extension
- Joined as a member company of the Korean Standards Association
- Completed national technical task agreement and implementation

## 2020

- Waterproof sheet eco-label certification
- ISO9001 post-secondary audit completed

## 2019

- Green Technology Recognition
- Applied for 6 patents

## 2018

- SK Construction ROOFENCE(anti-root) method applied
- Venture Business Certification
- Korea Excellent Brand Grand Prize(waterproofing material)
- Established corporate research institute

## 2017

- Undertaken the review of KS (Korea Industrial Standard) and ISO
- Commercialization of wet surface adhesive waterproof coating agent (cold glue)
- Extended the Eumseong Factory

## 2016

- Registered for the waterproofing method standardization of GS E&C
- Started consulting on the new construction technology  
: Wet surface adhesive waterproof coating agent (cold glue)
- Commercialization of butyl gum primer

## 2015

- Registered for the waterproofing method standardization of SK E&C
- Certified the clean business of Eumseong Factory
- LH: Passed the double composite waterproofing coating system test revised in 2015
- LH: Passed the adhesive type synthetic rubber based composite sheet test for outside waterproofing

## 2014

- Completed the Ahjin Layer Eumseong Factory
- Exported to 3 sites including the Seoheung Capsule Factory in Vietnam
- Commercialization of KSF-4934 butyl self-adhesive sheet

## 2013

- Women-friendly enterprise agreement  
: Ministry of Gender Equality and Family, Ministry of Employment and Labor, Bucheon City
- Application for the new construction technology  
: Korea Institute of Construction & Transportation Technology Evaluation and Planning (KICTEP)

## 2011

- Recognized as a R&D dedicated department
- Passed the 1st NEP examination managed by the Ministry of Knowledge Economy, and passed the preceding technology survey
- Selected as an e-trade utilization support business company in Bucheon City
- Participated in the Kyunghyang Housing Fair Exhibition
- Participated in the Khabarovsk Architectural Fair, Russia
- Selected as a company for which the evaluation cost of invention is supported as part of the excellent patent project support
- Awarded the citation of Korea Construction & Environment Technology Award (Minister of Knowledge Economy Award)
- Participated in the Beijing Architectural Fair, China

## 2010

- Registered as a venture business
- Designated as a New Deal Policy Company selected by Bucheon City
- Started the mass production of materials for LH

## 2009

- Ahjin Layer Co., Ltd. (Corporation registration)
- Started the mass production of the waterproofing material for multi-layer waterproofing

## 2008 ~ 2007

- Exported to the Mirmar 3-tower site, Angola
- Exported to the Angola Talatona Convention Hotel site, Angola
- Participated in the trade missions in Southeast Asia (Cambodia, Malaysia, and Thailand) hosted by Bucheon City
- Started the mass production of asphalt coating agent



# Cold layer® multi-layer and composite waterproofing method (Applying the method for each construction section)

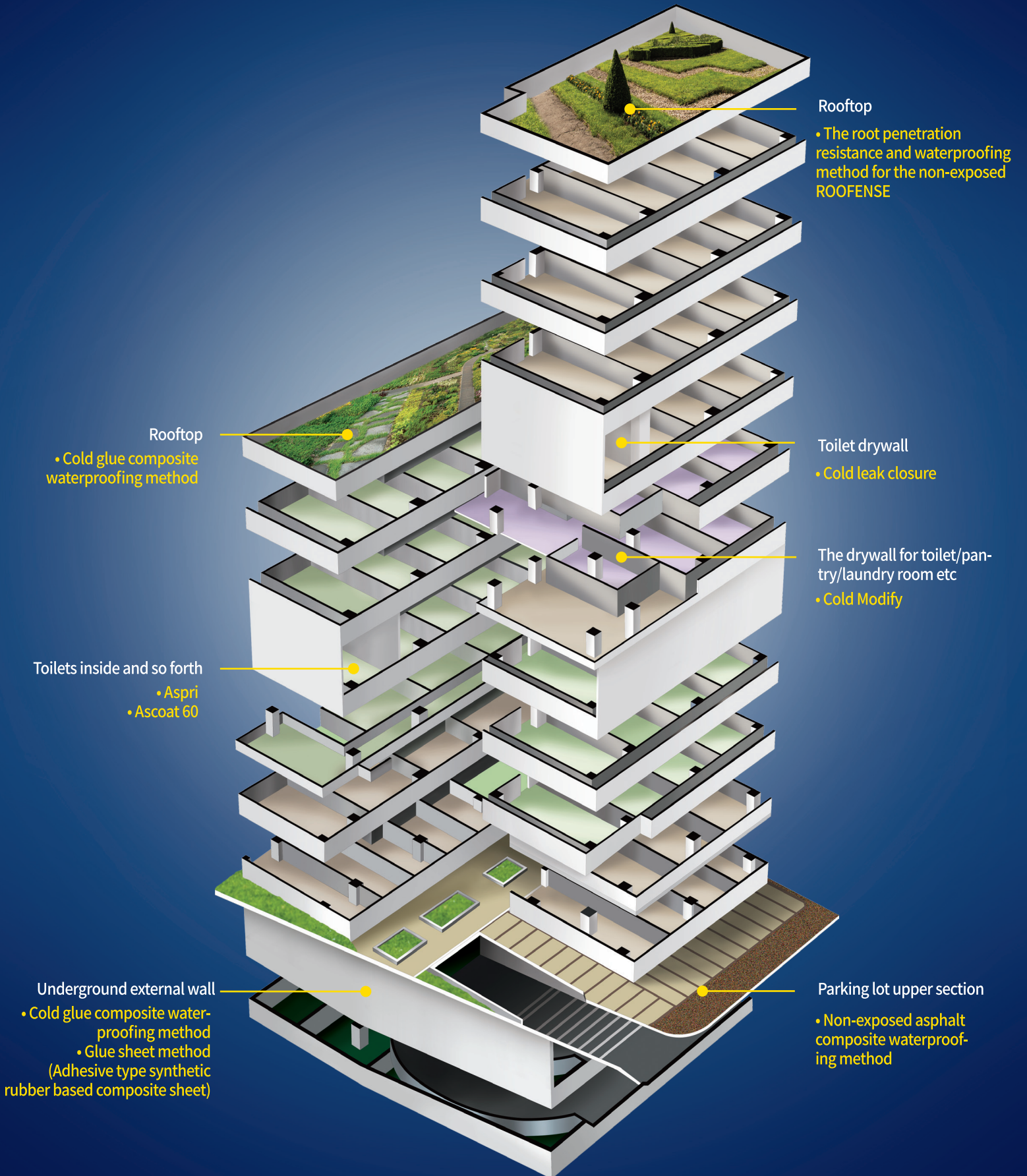

## ○ Advantages of the method

- ✓ The coating agent without the side effect of leaching
- ✓ The technology which can reduce the labor cost as it is fast and simple to be skillful
- ✓ Configured with 100% asphalt based materials
- ✓ The technology that does not sag or flow down in wall construction
- ✓ The technology that can be easily applied in four seasons with viscosity control



# AHJIN LAYER

## Composite waterproofing method

### ○ Ahjin layer's products

#### ▶ Membrane Sheets



#### ▶ Waterproof Coating



#### ▶ Subsidiary Materials



#### ▶ Emulsion Coating



#### ▶ Urethane Waterproof Coating



#### ▶ Bridge Deck Waterproof Coating



#### ▶ Cement Waterproof Coating





## ○ Introduction of the construction methods

Non-exposed method	One-piece 3C (ONE-PIECE 3C) composite method
	One-piece 3Z (ONE-PIECE 3Z) composite method
	Two-piece (TWO-PIECE) composite method
Wet adhesion method	Cold glue (ONE-PIECE 3G) wet adhesive composite method
Self-adhesive method	Butyl gum (ONE-PIECE 2P) sheet method
	Glue sheet method (Adhesive type synthetic rubber based composite sheet)
Exposed method	Exposed urecle (URECYL) composite method
Root penetration resistance method	ROOFENSE root penetration resistance composite method

## ○ Characteristics of the construction methods

- Providing the crack tape and kent tape attached to the bottom surface free of charge : Defect prevention effect
- Viscosity of main coating agent is adjustable : Securing the easiness of construction for the four seasons
- Using an exclusive coating agent for wall + breathable film : Fast construction/ prevention of sagging / prevention of bulging
- Using an exclusive coating agent for wall : Eliminating the side effects of flowing down or sagging
- Floor coating agent : No leaching after construction

## ○ Advancement of the construction method

Classification	Competitive method	Ahjin method
Floor construction	Frequent leaching after construction	No leaching cases
Wall construction	Because of using the sheet, • This method includes many processes • Sagging is occurred after construction	<ul style="list-style-type: none"> <li>• Using an exclusive coating agent + breathable film</li> <li>• Resolving the side effects of sagging and flowing down</li> </ul>
Corner construction	Using a thin nonwoven fabric	<ul style="list-style-type: none"> <li>• Use of PE laminated reinforcement tape (2 types)</li> </ul>

# Non-exposed ONE-PIECE 3C asphalt composite method

## Outline of the construction method

- A composite method of applying an asphalt coating agent to the floor and constructing an asphalt sheet with a non-woven fabric attached
- The wall is constructed with an advanced composite method that does not sag or run down by applying an asphalt coating that includes UV resistance.
- Prevent leakage with tape (kant tape, crack tape) for reinforcing weak areas such as corners

## Explanation of the construction method by construction section

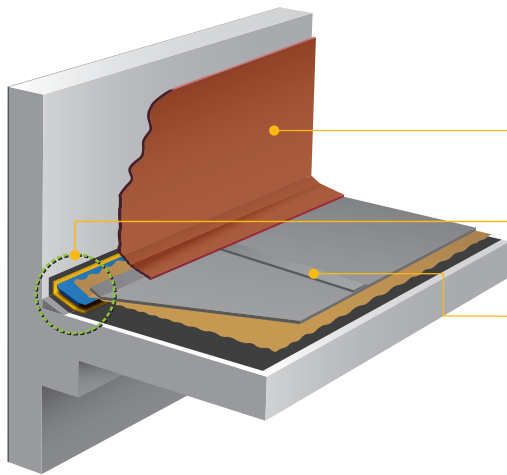

- No need for an additional V-CUT and so forth on the wall
- **Wall** : Applying the wall coating agent 2 times  
Improvement of difficult process / prevention of sagging / prevention of flowing down/fast construction
- **Corner** : Using the PE combined reinforced tape  
Maximization of waterproofing effect / reinforcing effect of vulnerable sections
- **Floor** : Sheet is attached only to the middle of the corner.  
Supplying the materials for the four seasons with the same viscosity / excellent constructability

## Downward construction of underground parking lot

- For the downward construction section, wall is constructed first and then followed by the floor construction.

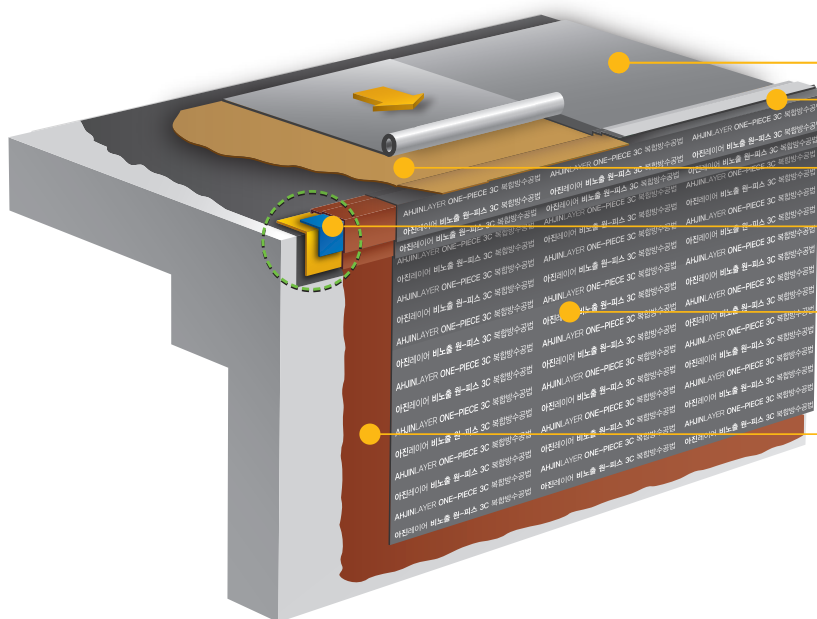

- Grit sheet
- COLD PLUS reinforcement at the sheet end
- COLD COMBINE application
- COLD PLUS application + Kent tape attaching
- Grit sheet
- COLD SPI application

○ Construction detail drawing of the construction method

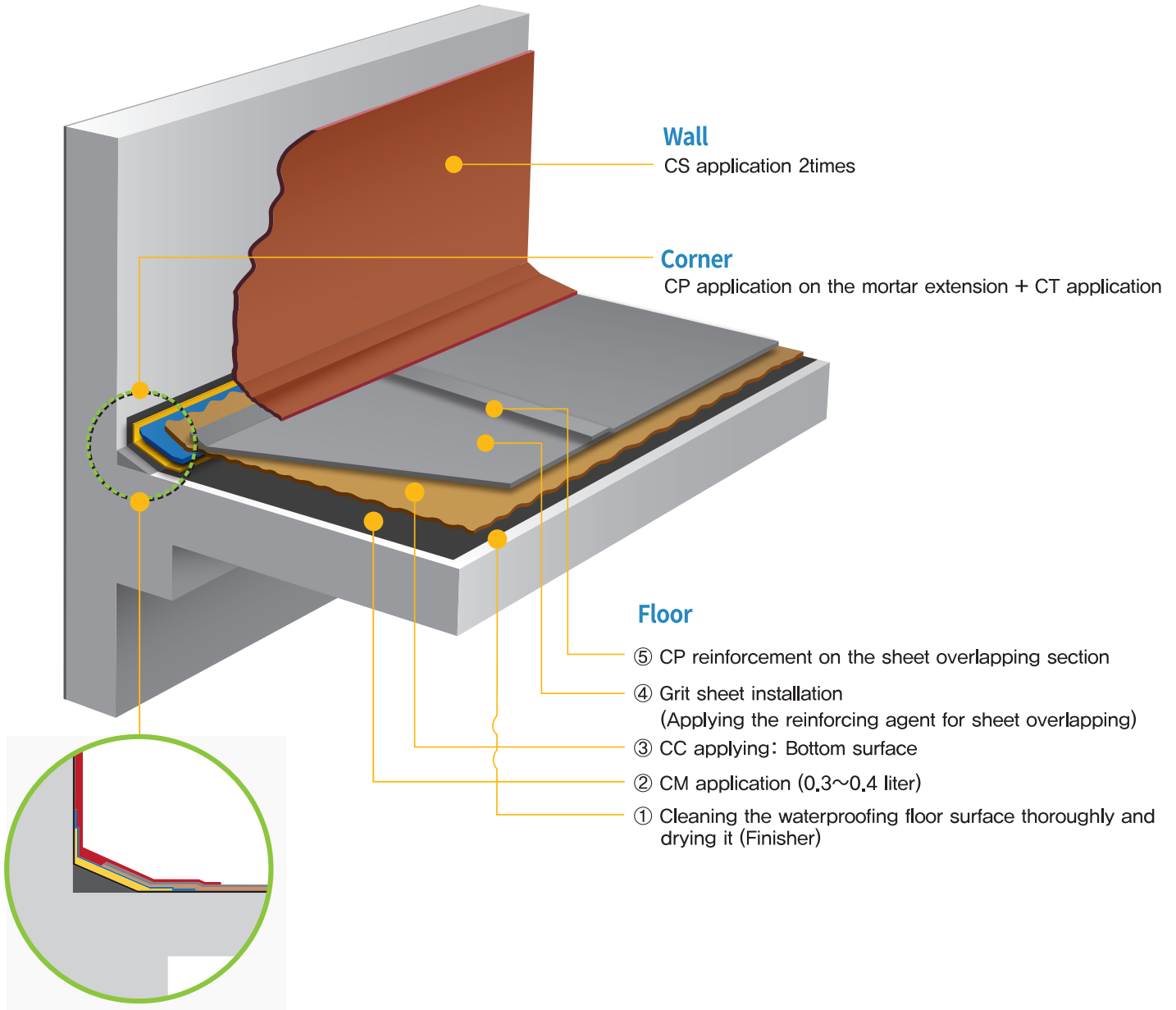

○ Sectional drawing for the laminated construction

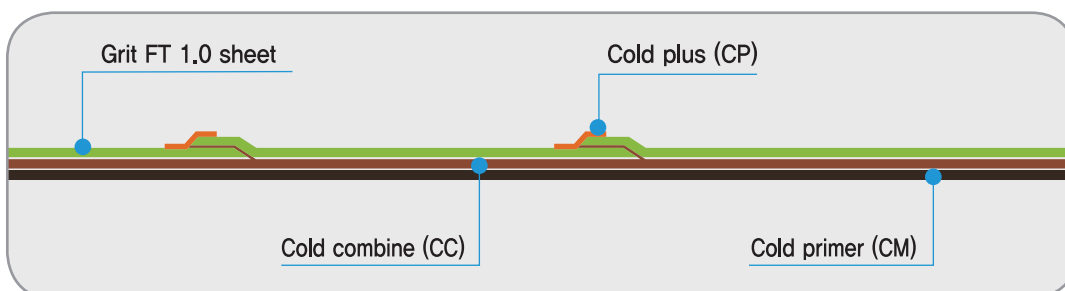

# Non-exposed **ONE-PIECE 3C** asphalt composite method

## ○ Construction sequence of the method

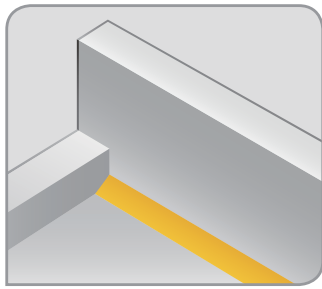

- ① Reinforcement work over corners  
(selection of cotton material is on-site)
- ② Finishing the wall form joint surface

1

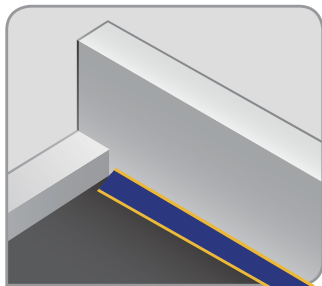

- ① Applying the asphalt primer(CM) on the floor  
(Not applying on the wall)
- ② Applying CP on the corners and simultaneously attaching the kent tape
- ③ Applying the primer down to the location just above the corner

2

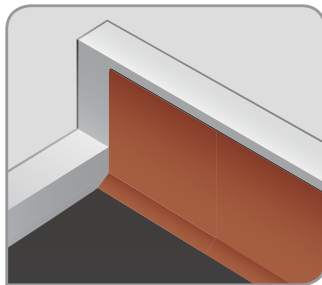

- ① 1st application of CS on the wall
- ② Apply the coating agent from the corner to the floor 10cm

3

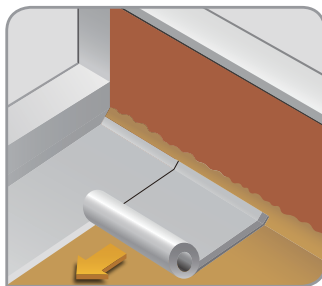

- When the wall construction is completed,
- ① Apply the floor coating agent(CC) and attach the Grit sheet at the same time
    - When installing the sheet in a corner, only raise it to the middle of the corner.
    - Apply CC to completely cover corners.
  - ② Application of overlap reinforcement(CP) after sheet installation



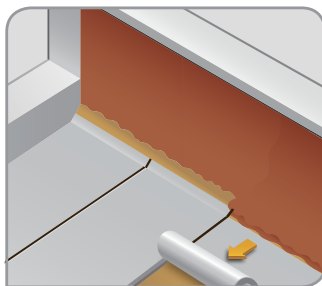

4

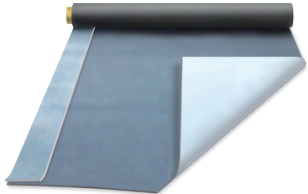

- When the floor construction is completed,
- ① 2nd application of CS on the wall
  - ② The CC for wall is applied down to 10 cm above the floor.
    - Be careful not to loosen the tip of the sheet at the corner section.

5

○ Material for one piece 3C

Materials for floor		<p><b>  Grit sheet (FT1.0)</b></p> <ul style="list-style-type: none"> <li>• Configured with the long fiber nonwoven fabric under the sheet</li> <li>• Installing the high adhesive layer on the overlapping section</li> <li>• The product which can be directly installed in rolling state</li> </ul>
		<p><b>  COLD COMBINE (CC)</b></p> <ul style="list-style-type: none"> <li>• The oil-based coating agent suitable for specification</li> <li>• Viscosity is adjustable for the four seasons - Excellent constructability</li> <li>• Containing zero moisture</li> <li>• Zero leaching side effect</li> </ul>
		<p><b>  COLD PLUS (CP)</b></p> <ul style="list-style-type: none"> <li>• The reinforcing material for sheet overlapping</li> <li>• As this is a hardening type, it has the double prevention effect for defect.</li> <li>• Preventing the self-cracking after construction due to soft physical properties</li> </ul>
		<p><b>  COLD PRIMER (CM)</b></p> <ul style="list-style-type: none"> <li>• Adjusting agent for the base surface</li> </ul>
Materials for wall		<p><b>  COLD SPI (CS)</b></p> <ul style="list-style-type: none"> <li>• Sheet replacing material as an exclusive coating agent for wall</li> <li>• Resolving the side effects of sagging or loosening after the curing</li> <li>• Forming the thickness of more than 1.5mm when applied</li> <li>• Containing the UV-resistant agent</li> </ul>

# Self-adhesive ONE-PIECE 2P asphalt composite method

## Outline of the construction method

The primer with reinforced adhesive strength is designed to reduce defects caused by the step difference in the adhesive layer, and Two release films mounted on the bottom of the sheet can be make to unroll the sheet during construction.

So, it can be prevent sheet deformation, save materials and make fast construction.

## Explanation of the construction method by construction section

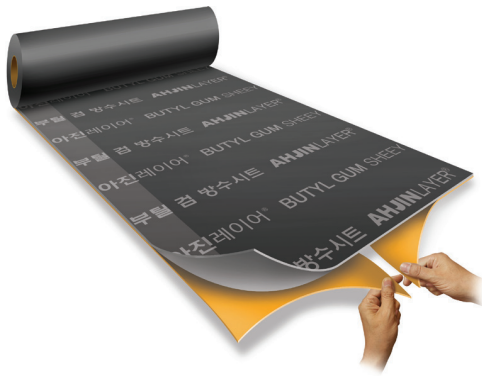

### ■ V-CUT on the wall

Wall : Use of reinforcing agent for adhesive bonding to the end of the sheet  
Function to improve difficult process / Prevent sagging / Do not perforate the waterproof layer

Corner : Eco-friendly reinforcing material with adhesive bonding  
Maximizing waterproofing effect/reinforcing weak areas / considering worker safety

Floor : Prevent defects by using a strong primer  
Reinforced step decomposition function compared to existing products / excellent workability

## Downward construction of underground parking lot

■ For the downward construction section, wall is construction first and then followed by the floor construction.

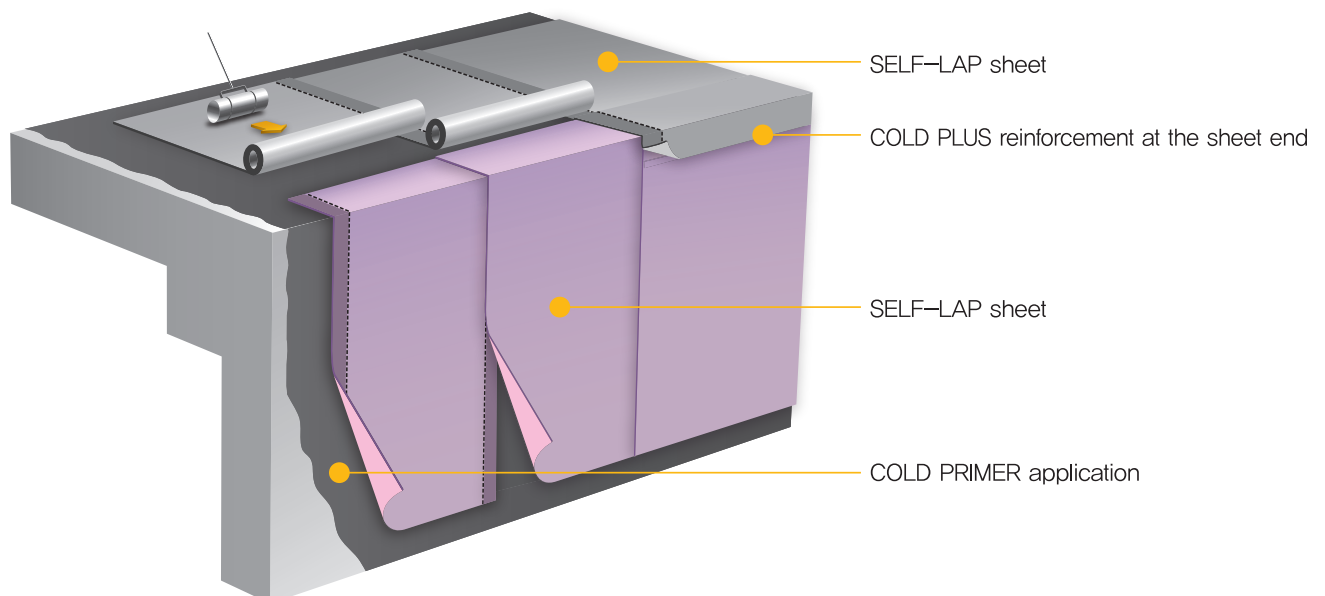

## ○ Construction detail drawing of the construction method

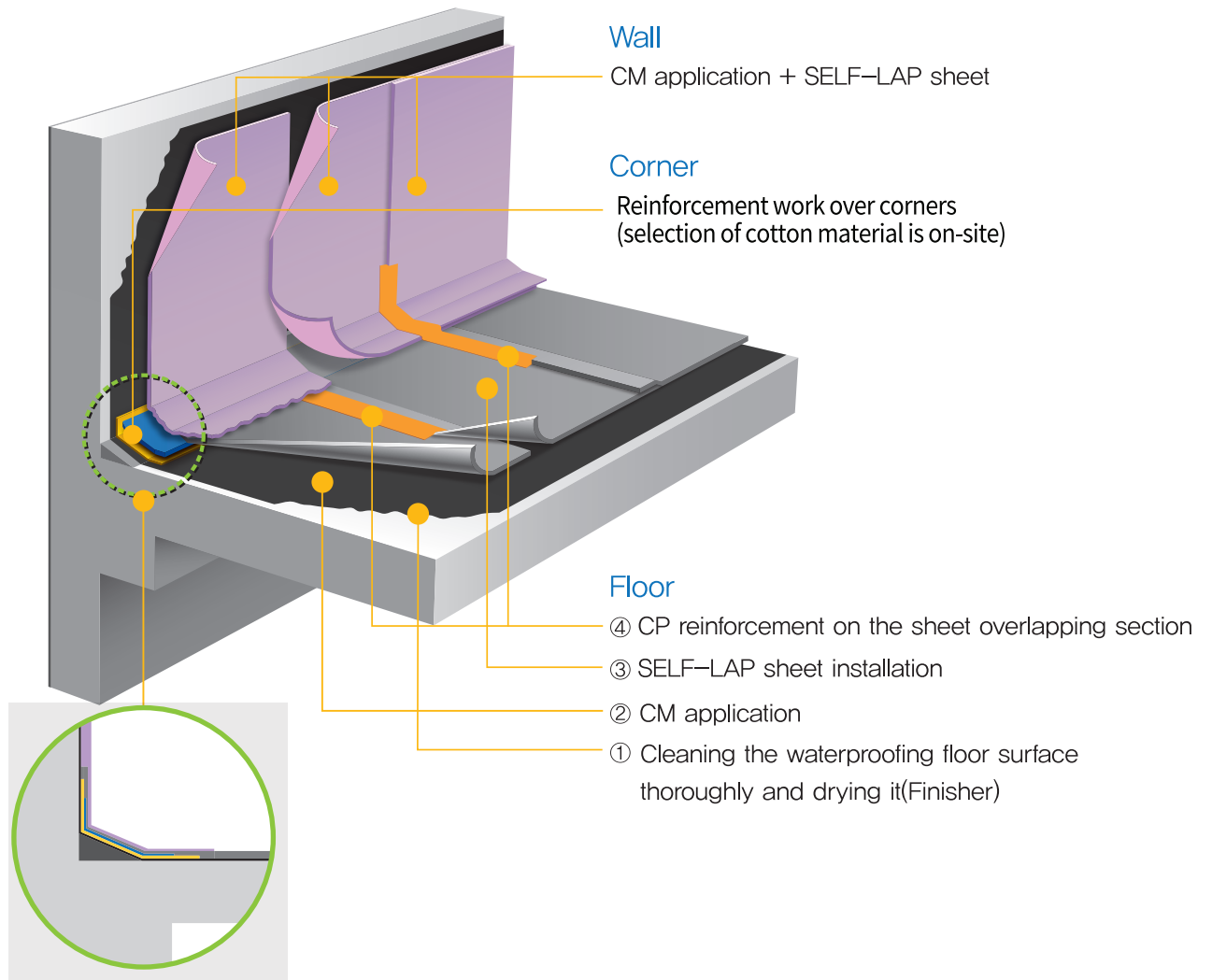

## ○ Sectional drawing for the laminated construction

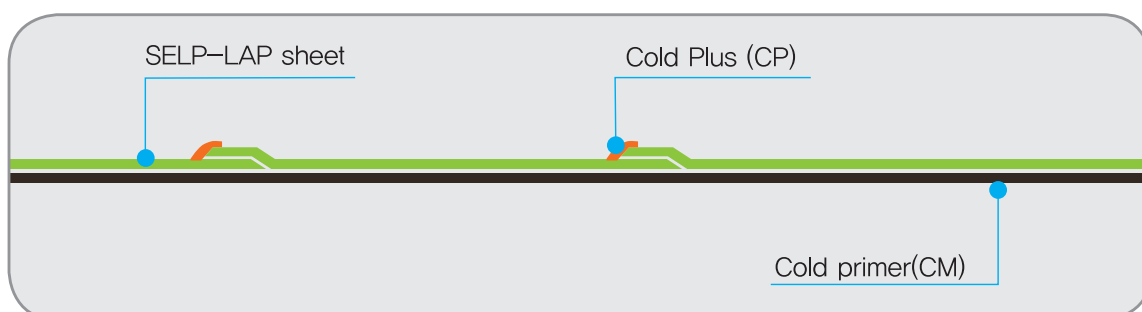

# Self-adhesive **ONE-PIECE 2P** asphalt composite method

## ○ Construction sequence of the method

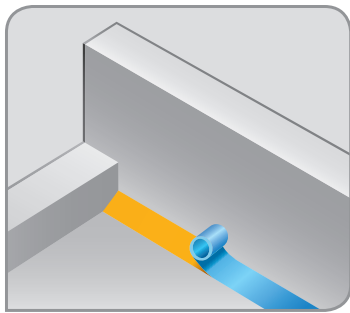

- ① Reinforcement work over corners (selection of cotton material is on-site)
- ② Finishing the wall form joint surface

1

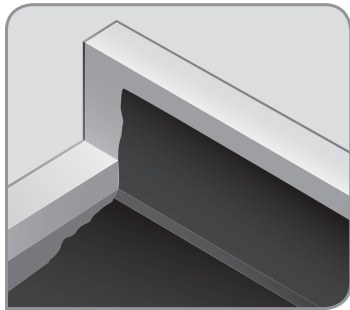

- ① Applying the asphalt primer(CM) on the floor and wall
- ② Applying CP on the corners and simultaneously attaching the kent tape
- ③ Applying CP to the crack area and attaching crack tape at the same time

2

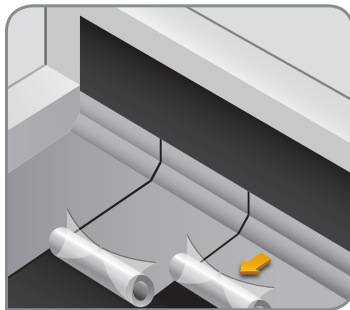

- ① Install Self-lap sheet from the floor through the corner to 10 cm above the wall.
- ② Be careful not to lift the bent part when attaching it to the corner.
- ③ Spread the sheet over the construction area and check if the overlapping area matches.
- ④ After checking the overlap, peel off the two release films from the bottom of the sheet alternately and install

3

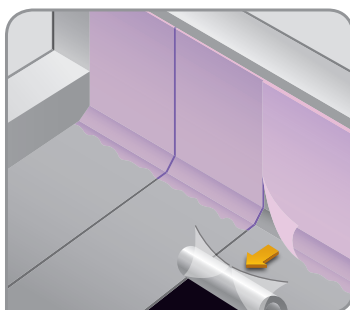



- When the floor construction is completed,
- ① Attach the SELF-LAP sheet to the wall in order
  - ② Be careful not to lift the bent part when attaching it to the corner.
  - ③ Sheets are installed from the wall through the corner to 10cm on the floor .
  - ④ Application of overlap reinforcement(CP)

4

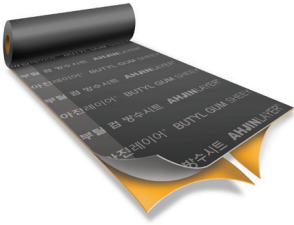

○ Material for one piece 2P

<p>Materials for floor and Wall</p>		<p>  SELF-LAP SHEET</p> <ul style="list-style-type: none"> <li>• The bottom part of the sheet consists of two release films,</li> <li>• Eco-friendly adhesive used in the overlapping parts of the sheets,</li> <li>• Can be installed with all seats unrolled</li> </ul>
		<p>  COLD PLUS (CP)</p> <ul style="list-style-type: none"> <li>• Reinforcement material for Sheet overlapping part</li> <li>• Double defect prevention effect with hardening type</li> <li>• Prevention of self-cracking after construction with soft properties</li> </ul>
		<p>  COLD PRIMER (CM)</p> <ul style="list-style-type: none"> <li>• Primer with increased adhesion</li> <li>• adjusting agent for the base surface</li> </ul>

# ROOFENSE

## Root Penetration resistance method

### ○ Outline of the construction method

- A method of applying an anti-root coating agent and attaching an anti root sheet with proven anti root performance at the same time
- Composite anti-root method including anti-root and waterproofing technique

### ○ Construction detail drawing of the construction method

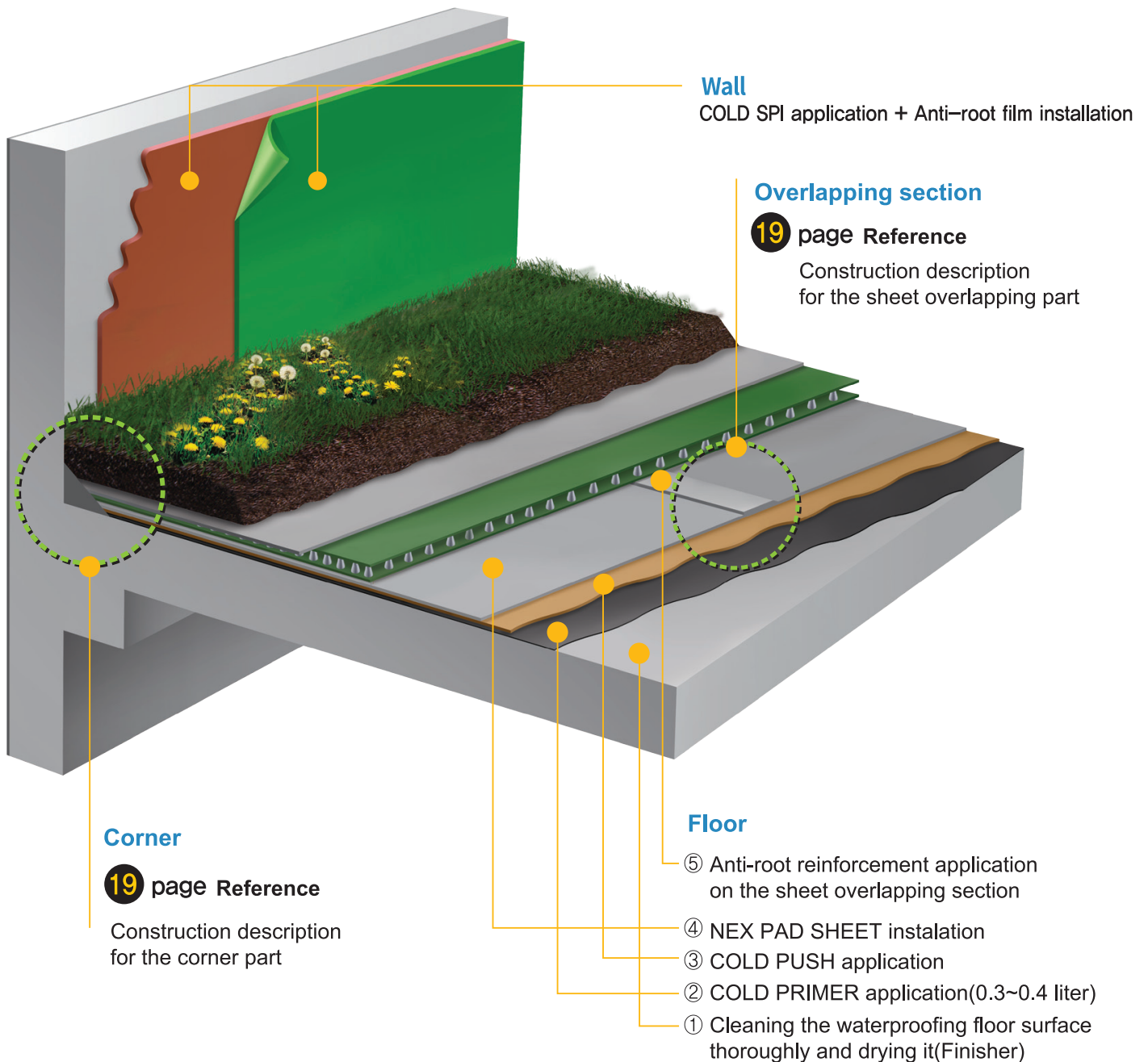

## ○ Description of the method for overlapping sheets

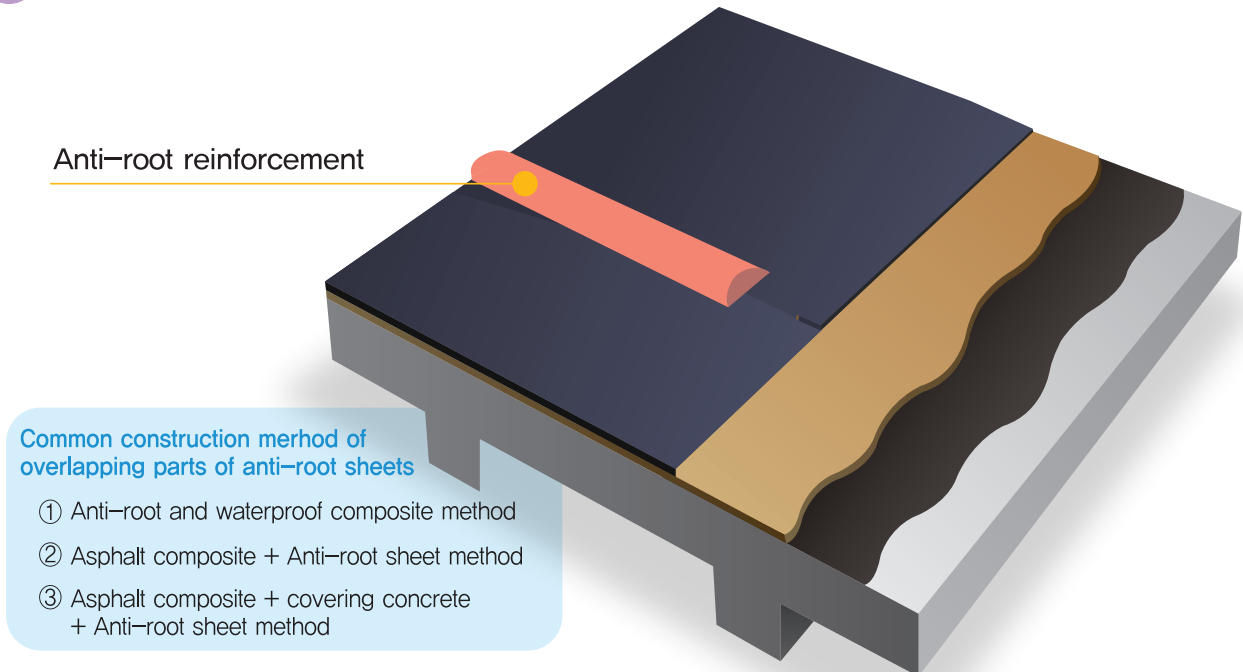

## ○ Description of the method for corner

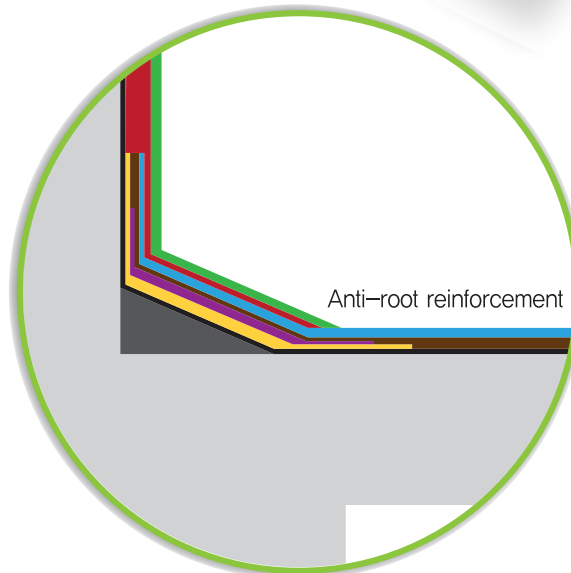

## ○ Sectional drawing for the laminated construction

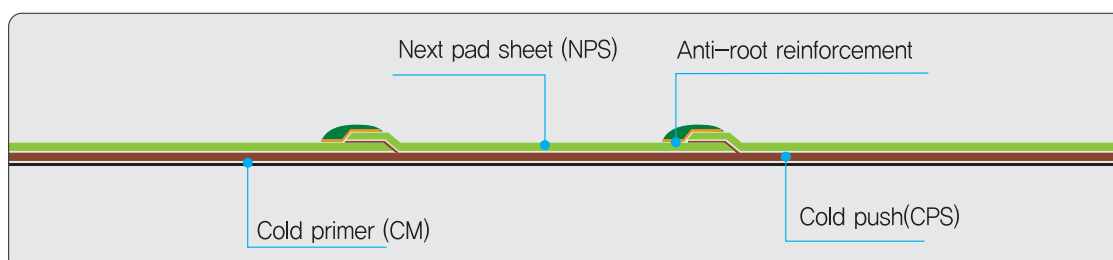

# ROOFENSE

## Root Penetration resistance method

### ○ Construction sequence of the method

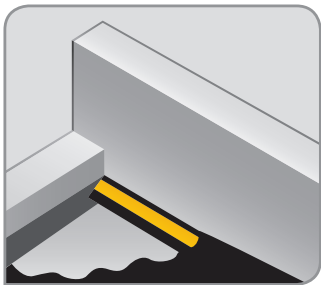

- ① Surface treatment (urethane sealant or waterproof mortar)
- ② Applying the asphalt primer(CM) on the floor and corner  
(Not applying on the wall)

1

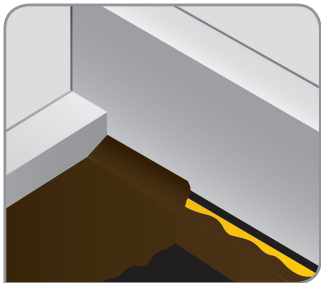

- ① Application of CPS on the floor and corner

2

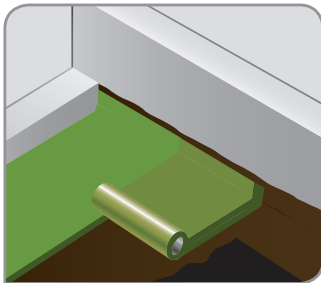

- ① NPS(anti root sheet) installation at the same time as cold push application
- ② CPS application on the overlapping part
- ③ NSP is installed up to the top of the corner

3

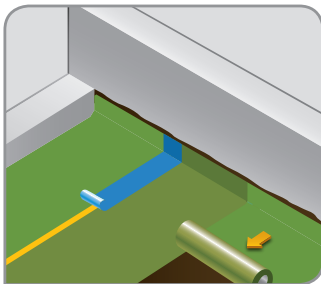

- ① Anti-root reinforcement application on the sheet overlapping section

4

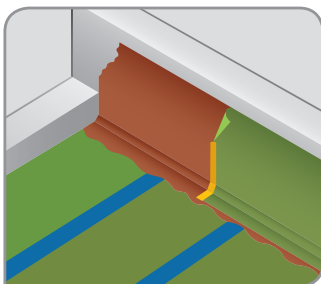

- When the floor construction is completed,
- ① Apply CS to the wall and attach the anti-root film
  - ② Attach the film before CS hardens.
  - ③ CS and film is applied down to 10cm above the floor.
  - ④ Construction of protective materials

5

○ Material for Roofense

Materials for floor		<p>  COLD PRIMER (CM)</p> <ul style="list-style-type: none"> <li>• Adjusting agent for the base surface</li> </ul>
		<p>  COLD PUSH (CPS)</p> <ul style="list-style-type: none"> <li>• 1-component type</li> <li>• Integrate with concrete as dry type</li> <li>• Coating waterproofing agent with anti-root performance</li> </ul>
		<p>  NEX PAD SHEET (NPS)</p> <ul style="list-style-type: none"> <li>• Anti-root sheet(1.0m)</li> <li>• Direct installation in roll condition</li> <li>• 1,0mm thick</li> <li>• Cold construction method</li> </ul>
Materials for Wall		<p>  COLD SPI (CS)</p> <ul style="list-style-type: none"> <li>• Sheet replacing material as an exclusive coating agent for wall</li> <li>• Resolving the side effects of sagging or loosening after the curing</li> <li>• Containing the UV-resistant agent</li> </ul>
		<p>  ANTI-ROOT FILM</p> <ul style="list-style-type: none"> <li>• Anti-root film for wall</li> <li>• 0,05mm thick</li> <li>• Pet-based film</li> </ul>
Materials for floor and Wall		<p>  COLD PLUS (CP)</p> <ul style="list-style-type: none"> <li>• Reinforcement material for Sheet overapping part</li> <li>• Double defect prevention effect with hardening type</li> <li>• Prevention of self-cracking after construction with soft properties</li> </ul>

# AHJIN LAYER

## Composite waterproofing method

### Patent certificates and quality certifications

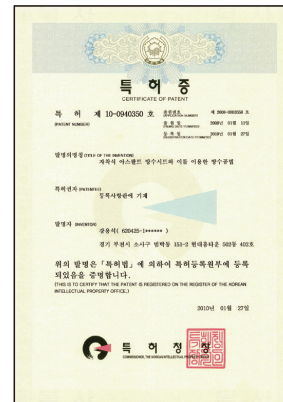
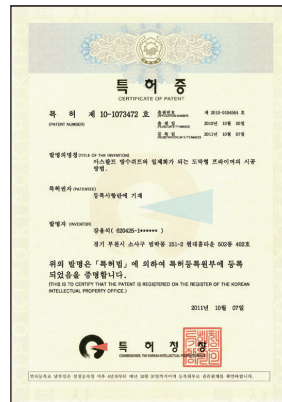
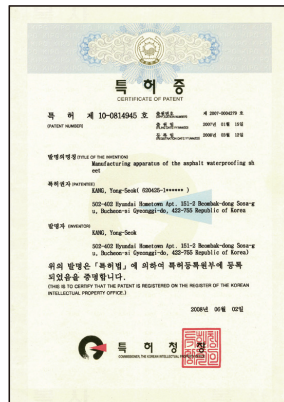
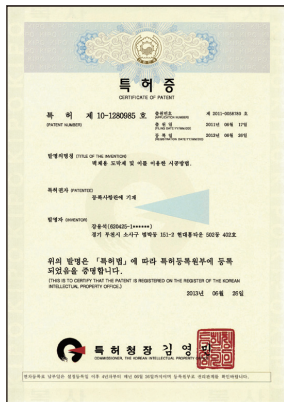
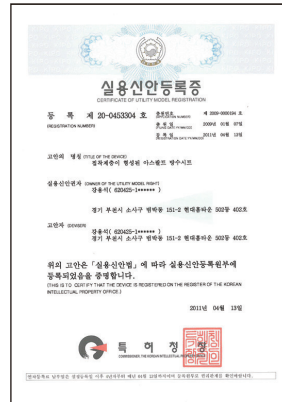
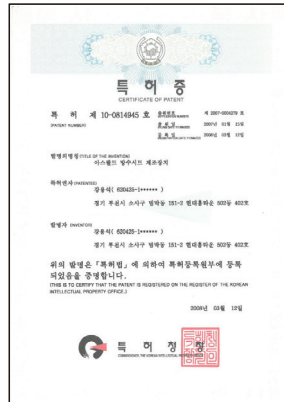
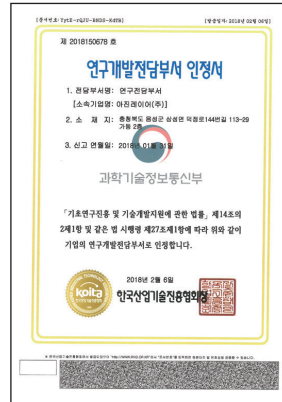
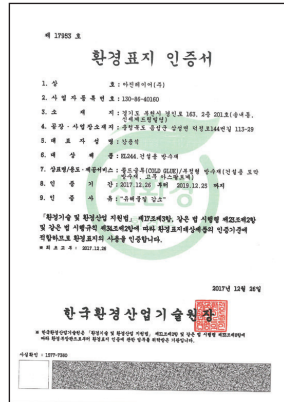
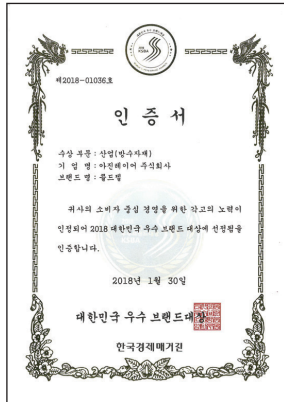
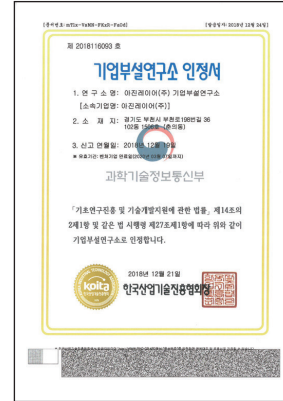
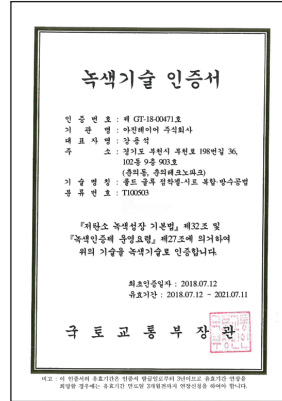
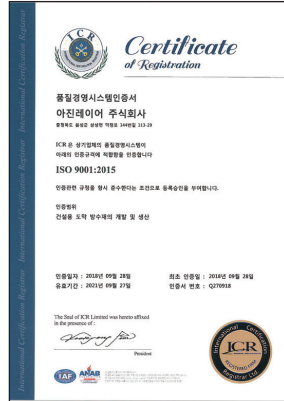
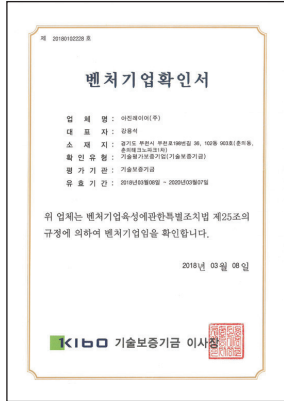

Patent certificates and quality certifications

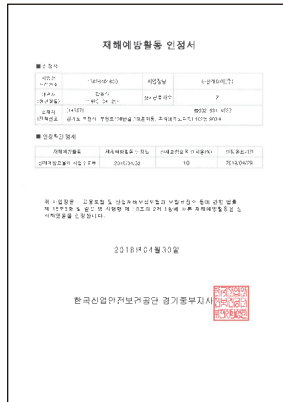
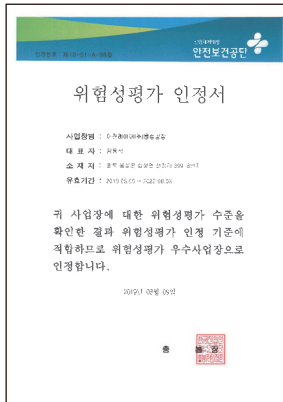
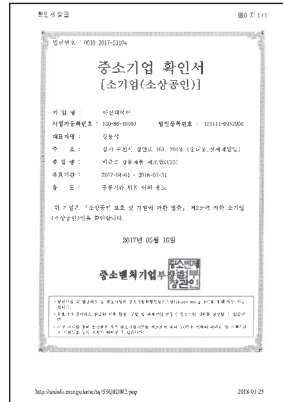
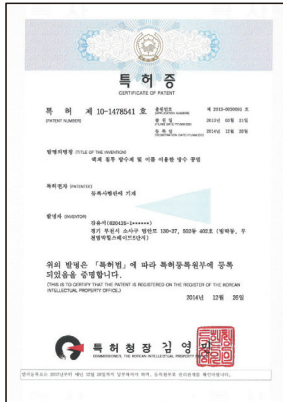
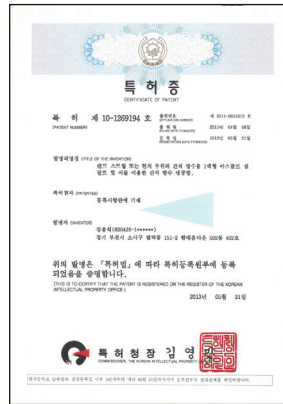
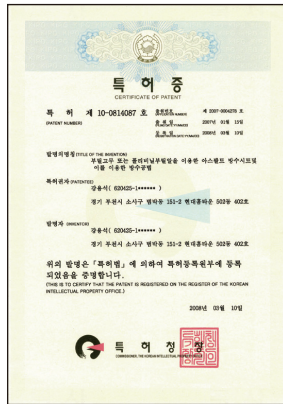
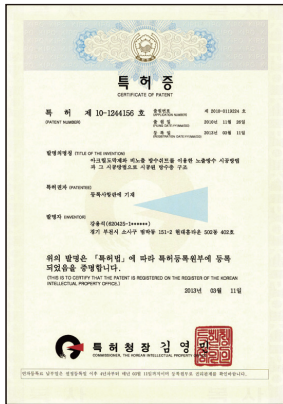



**AHJINLAYER®**

[www.ahjinlayer.co.kr](http://www.ahjinlayer.co.kr)

Ahjin Layer

Head office : 102-dong 1506, Chunui Techno Park 1st,  
36, Bucheon-ro 198beon-gil, Bucheon-si, Gyeonggi-do, Korea  
T.+82.32.661.4530 F.+82.32.661.4534

Factory : 28, Geumwangtekeuno 5-gil, Geumwang-eup, Eumseong-gun,  
Chungcheongbuk-do, Korea  
T.+82.43.883.4530 F.+82.43.878.4532